



# SC5813

3 Heat/2 Cool  
Auto Changeover  
Hardwire

Programmable Electronic Thermostat

- 7-Day, 5-2-Day or 5-1-1-Day Programmable
- Configurable
- 3-Stage Heat/2-Stage Cool Systems
- 3-Stage Heat Pump Systems
- Large Display With Backlight
- Selectable Fahrenheit or Celsius
- Compatible with Gas, Oil, or Electric
- SimpleSet™ Field Programming
- Status Indicator Light
- Relay Outputs (minimum voltage drop in thermostat)
- Remote Sensor Compatible
- Ideally Suited for:
  - Residential (New Construction/Replacement)
  - Light Commercial



## Installation, Operation & Application Guide

For more information on our complete range of American-made products – plus wiring diagrams, troubleshooting tips and more, visit us at [www.icmcontrols.com](http://www.icmcontrols.com)



## Parts Diagram

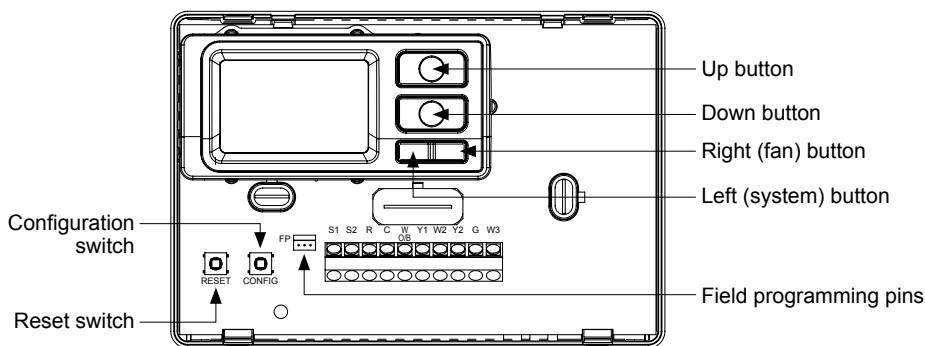

## Icon Descriptions

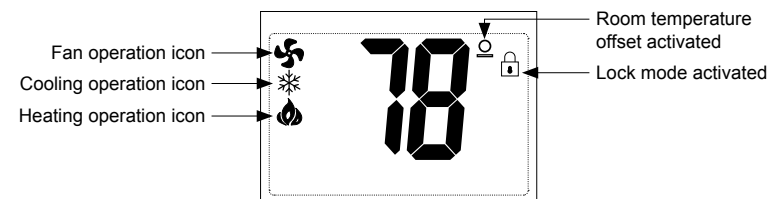

## Specifications

- Electrical rating:**
- 24 VAC (18-30 VAC)
  - 1 amp maximum per terminal
  - 3 amp maximum total load
- Temperature control range:** 45°F to 90°F (7°C to 32°C) **Accuracy:** ± 1°F (± 0.5°C)
- System configurations:** 3-stage heat, 2-stage cool, heat pump, gas, oil, electric
- Timing:** Anti-short Cycle: 4 minutes (bypass anti-short cycle delay by returning to OFF mode for 5 seconds)  
Backlight Operation: 10 seconds
- Terminations:** S1, S2, R, C, W/O/B, Y1, W2, Y2, G, W3

## Important Safety Information

- WARNING!** Always turn off power at the main power supply before installing, cleaning, or removing thermostat.
- This thermostat is for 24 VAC applications only; do not use on voltages over 30 VAC
  - Do not short across terminals of gas valve or system control to test operation; this will damage your thermostat and void your warranty
  - All wiring must conform to local and national electrical and building codes
  - Do not use air conditioning when the outdoor temperature is below 50 degrees; this can damage your A/C system and cause personal injuries
  - Use this thermostat only as described in this manual

## Package Contents/Tools Required

**Package includes:** SC5813 PRO thermostat on base, thermostat cover, wiring labels, screws and wall anchors, Installation, Operation and Application Guide

**Tools required for installation:** Drill with 3/16" bit, hammer, screwdriver

## To Remove Existing Thermostat

- ELECTRICAL SHOCK HAZARD – Turn off power at the main service panel by removing the fuse or switching the appropriate circuit breaker to the OFF position before removing the existing thermostat.**
1. Turn off power to the heating and cooling system by removing the fuse or switching the appropriate circuit breaker off.
  2. Remove cover of old thermostat. This should expose the wires.
  3. Label the existing wires with the enclosed wire labels before removing wires.
  4. After labeling wires, remove wires from wire terminals.
  5. Remove existing thermostat base from wall.
  6. Refer to the following section for instructions on how to install this thermostat.

## To Install Thermostat

- ELECTRICAL SHOCK HAZARD – Turn off power at the main service panel by removing the fuse or switching the appropriate circuit breaker to the OFF position before removing the existing thermostat.**
- IMPORTANT:** Thermostat installation must conform to local and national building and electrical codes and ordinances.
- \*. Note: Mount the thermostat about five feet above the floor. Do not mount the thermostat on an outside wall, in direct sunlight, behind a door, or in an area affected by a vent or duct.
1. Turn off power to the heating and cooling system by removing the fuse or switching the appropriate circuit breaker off.
  2. To remove cover, pull gently at the seam at the top.
  3. Put thermostat base against the wall where you plan to mount it (Be sure wires will feed through the wire opening in the base of the thermostat).
  4. Mark the placement of the mounting holes.
  5. Set thermostat base and cover away from working area.
  6. Using a 3/16" drill bit, drill holes in the places you have marked for mounting.
  7. Use a hammer to tap supplied anchors in mounting holes.
  8. Align thermostat base with mounting holes and feed the control wires through slit in thermal intrusion barrier and into wire opening.
  9. Use supplied screws to mount thermostat base to wall.
  10. Insert stripped, labeled wires in matching wire terminals.
- CAUTION!** Be sure exposed portion of wires does not touch other wires.
11. Gently tug wire to be sure of proper connection. Double check that each wire is connected to the proper terminal.
  12. Turn on power to the system at the main service panel.
  13. Configure thermostat to match the type of system you have.
  14. Replace cover on thermostat by snapping it in place.
  15. Test thermostat operation as described in "Testing the Thermostat".

## Wiring Diagrams

### Heat/Cool Systems

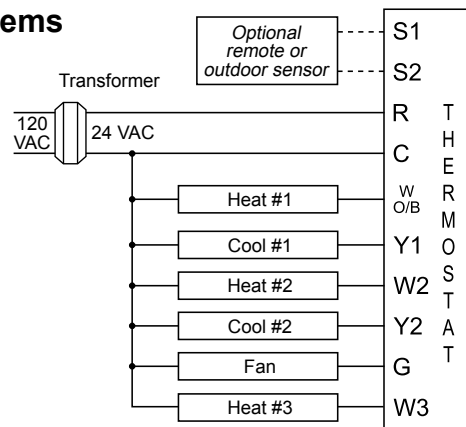

### Single Compressor heat pump with electric backup

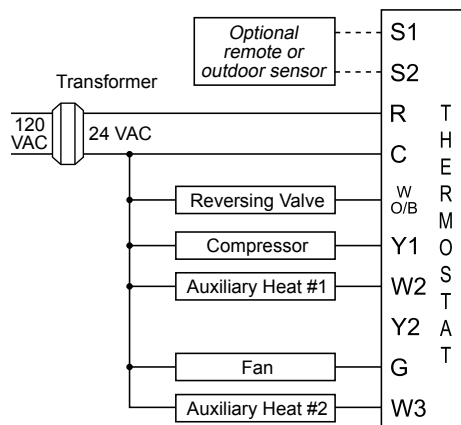

### Dual Compressor heat pump with electric backup

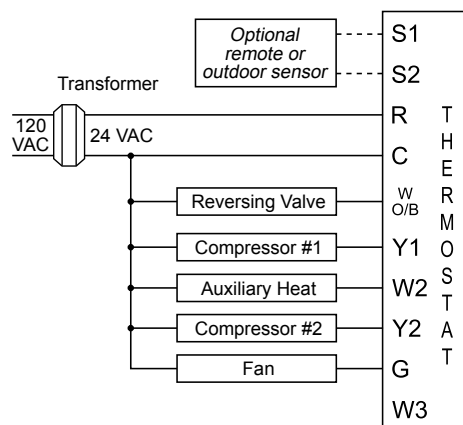

## Remote Sensor Installation (Optional)

Terminals S1 and S2 can be used for an indoor remote sensor. The indoor remote sensor is used to read the indoor temperature in a different location. This is beneficial when the thermostat is not mounted in the ideal location.

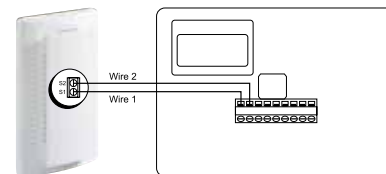

**Remote Sensor:** (Shown: Optional ICM ACC-RT103 Remote Indoor Sensor; for outdoor sensor, order ACC-OD103.)

\*. Note: Remote or outdoor sensor reading can be displayed by simultaneously pressing the Down and SYS buttons.

1. Remove cover from remote sensor housing.
2. Select an appropriate location for mounting the remote sensor.
3. Mount remote sensor unit using hardware provided.
4. Install two strand shielded wire between remote sensor and thermostat. Shielded wire is recommended.
  - **Wire 1** should run between the S1 terminal on the thermostat and the S1 terminal on the remote sensor
  - **Wire 2** should run between the S2 terminal on the thermostat and the S2 terminal on the remote sensor
  - Connect the shielding of the wire to the S2 terminal on the thermostat
5. Configure the thermostat to operate with the remote indoor sensor (see Configuration Mode setting 14).

## Terminal Designator Descriptions

- R – 24 VAC hot
- C – 24 VAC common
- W1/O/B – Configurable
- W1 – 1st stage heat for non-heat pump systems O – cool active reversing valve B – heat active reversing valve
- Y1 – 1st stage cool, 1st stage heat for heat pumps
- W2 – 2nd stage heat for 1 compressor heat pump and non-hp, 3rd stage heat for 2 compressor heat pump systems
- Y2 – 2nd stage cool for 2 compressor systems, 2nd stage heat for 2 compressor heat pump systems
- G – Fan
- W3 – 3rd stage heat for non-hp systems and 1 compressor heat pump systems

## SC5813 Output Chart

	1 <sup>st</sup> Cool	2 <sup>nd</sup> Cool	1 <sup>st</sup> Heat	2 <sup>nd</sup> Heat	3 <sup>rd</sup> Heat
Heat/Cool	Y1, G	Y1, Y2, G	W1, G*	W1, W2, G*	W1, W2, W3, G*
Heat Pump (One Compressor)	Y1, G, O	Y1, G, O	Y1, G, B	Y1, W2, G, B	Y1, W2, W3, G, B
Heat Pump (Two Compressors)	Y1, G, O	Y1, Y2, G, O	Y1, G, B	Y1, Y2, G, B	Y1, Y2, W2, G, B
Emergency Heat (Heat Pump Only)	N/A	N/A	W2, G	W2, W3, G	N/A

\* G not energized when configured as a gas/oil system

The SC5813 thermostat is configurable for all systems. The configuration directly affects the outputs. Use the output chart to correctly configure and wire the thermostat to your system.

## Configuration Mode

The configuration mode is used to set the SC5813 to match your heating/cooling system. The SC5813 functions with heat pump, air conditioning, gas, oil or electric heat systems.

To configure the SC5813, perform the following steps:

1. Verify the SC5813 is in the OFF mode. Press the SYS (left) button until off mode displays.
2. Remove the cover of the thermostat by gently pulling near one of the corners at the top of the thermostat.
  - \*. Note: Do not force open. Use a small coin or slotted screwdriver to release tabs if necessary.
3. Press the CONFIG button for 1 second while the SC5813 is in OFF mode.

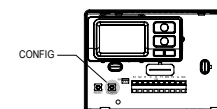

Press the up or down button to change settings within each screen.

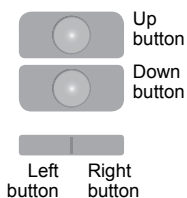

Press the right button to advance to the next screen.

\*. Note: Pressing the left button will return you to the previous screen.

To exit configuration mode, press the CONFIG switch for 1 second.

## Configuration Mode Settings

The setup screens for Configuration Mode are as follows:

1. **Temperature Scale (F or C)**  
Choose Fahrenheit or Celsius. Press the up or down button to select. Press the right button to advance to the next screen.
2. **1<sup>st</sup> Stage Temperature Differential (1°F to 5°F) (0.5°C to 2.5°C)**  
Set the number of degrees between your "setpoint" temperature and your "turn on" temperature. Press the up or down button to set differential value. Press the right button to advance to the next screen.
3. **2<sup>nd</sup> Stage Temperature Differential (1°F to 5°F) (0.5°C to 2.5°C)**  
Set the number of degrees between when stage 1 turns on and when stage 2 turns on. Press the up or down button to set differential value. Press the right button to advance to the next screen.

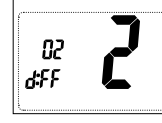
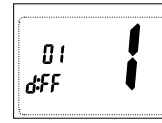
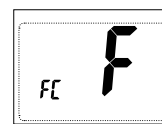

4. **3<sup>rd</sup> Stage Temperature Differential (1°F to 5°F) (0.5°C to 2.5°C)**  
Set the number of degrees between when stage 2 turns on and when stage 3 turns on. Press the up or down button to set differential value. Press the right button to advance to the next screen.

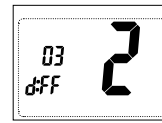

5. **Staged Off Outputs**  
Select whether the outputs for heating and cooling are staged off independently or are satisfied simultaneously. 1 = outputs staged off independently 0 = outputs off simultaneously  
\*. Note: For 2 compressor heat pumps and multi-stage gas/oil systems, stage 3 is staged off independently when SO is set to O.  
Press the up or down button to set. Press the right button to advance to the next screen.

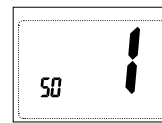

6. **Minimum Deadband (1°F to 9°F) (1°C to 5°C)**  
Set the minimum separation between heat setpoint and cool setpoint in Auto Changeover Mode. Press the up or down button to set deadband value. Press the right button to advance to the next screen.

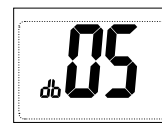

7. **System** – Set for heat pump, non-heat pump, reversing valve operation and number of compressors in your system.

Choose	System	Reversing Valve Active	Number of Compressors or Compressor Stages	Type of Heat
Heat Pump	HP	O	1	
	HP	b	1	
	HP	O	2	
	HP	b	2	
Non-Heat Pump	Heat			Gas
	Heat			Electric

Press the up or down button to select. Press the right button to advance to the next screen.

8. **Auxiliary Delay ON (0-30 minutes)**  
Set the delay time in minutes for auxiliary heat to be locked out after a call for second stage. This extra savings feature is used to temporarily lock out auxiliary heat devices, allowing just heat pump to try to satisfy heat call. Press the up or down button to select. Press the right button to advance to the next screen.

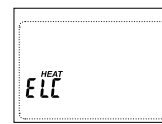

9. **Lockout (0-8°, NITE, COOL-HEAT)**  
Select the number of degrees set temperature can be changed during keypad lockout or select to lockout during NITE period only. COOL-HEAT lockout allows adjustment of the set temperatures to the maximum heat set temperature selected in Step 10 and minimum cool set temperature selected in Step 11.

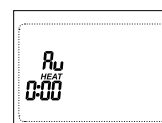

\*. Note: The mode cannot be changed when the thermostat is locked. Press the up or down button to select. Press the right button to advance to the next screen.

10. **Maximum Heat Setpoint (45°F to 90°F) (7°C to 32°C)**  
Adjust to control the maximum heat set temperature allowed. Press the up or down button to select. Press the right button to advance to the next screen.

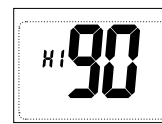

11. **Minimum Cool Setpoint (45°F to 90°F) (7°C to 32°C)**  
Adjust to control the minimum cool set temperature allowed. Press the up or down button to select. Press the right button to advance to the next screen.



12. **Room Temperature Offset (+9°F to -9°F) (+4.5°C to -4.5°C)**  
Adjust to calibrate displayed room temperature to match actual room temperature. \*. Note: When not set to 0, will display  
Press the up or down button to select. Press the right button to advance to the next screen.

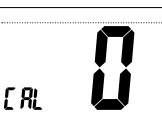

13. **Maximum Cycles Allowed Per Hour (-, -, 2-6)**  
-- = as many as needed, 2-6 = maximum cycles/hour  
Press the up or down button to select. Press the right button to advance to the next screen.

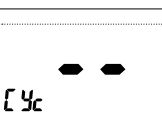

14. **Temperature Sensor (1-4)**
  1. Only on-board sensor determines room temperature.
  2. Only remote sensor determines room temperature.
  3. Average temperature of on-board and remote sensor.
  4. Only on-board sensor will be used until NITE period, and then only remote sensor is used.
 \*. Note: If there is no remote sensor, option 1 must be selected. Press the up or down button to select. Press the right button to advance to the next screen.

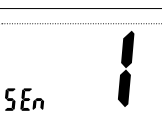

15. **Cooling Fan Delay Off Time (0, 30, 60, 90 seconds)**  
Select the fan purge time for cooling. Press the up or down button to select. Press the right button to advance to the next screen.

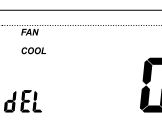



16. **Status Indicator Light** (Led 0, 1, 2, 3)  
 0 = Status indicator never on  
 1 = Status indicator on with first stage  
 2 = Status indicator on with second stage  
 3 = Status indicator on with third stage  
 Press the **up** or **down** button to select.  
 Press the **CONFIG** button for 2 seconds to exit configuration.

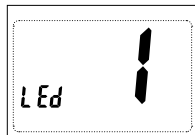

## Mode of Operation

The **SC5813** is a programmable, manual or auto changeover, 3-stage heat, 2-stage cool thermostat. It functions with air conditioning, heat pumps, gas, oil or electric heat systems.

The thermostat activates the heating appliance when the room temperature is below the set heat temperature (by the differential temperature) and the red indicator light (configurable) on the thermostat will light. The **SC5813** will stop outputting and the red light will turn off when the call for heat has been satisfied. With heat pumps, the thermostat will not let the compressor come on for 4 minutes after it turns off. This protects your compressor.

When the room temperature is greater than the set cool temperature (by the differential temperature), the cooling device is activated and the green indicator light (configurable) on the thermostat will turn on. The **SC5813** will stop outputting and the green light will turn off when the call for cooling is satisfied. The thermostat will not let the compressor come on for 4 minutes after it turns off. This protects your compressor.

The **SC5813** has five possible operating modes: **OFF**, **Heat**, **Cool**, **Heat & Cool**, and **Program** mode. In off mode, the thermostat will not turn on heating or cooling devices. The manual fan can be turned on in all operating modes using the fan button. In heat mode, the thermostat controls the heating system. In the cool mode, the thermostat controls the cooling system. In heat & cool mode, the thermostat controls both the heating and cooling systems. In program mode, the thermostat will automatically be controlled by the set program. Program mode can function with heat mode, cool mode, or heat & cool mode. The clock display alternates with the set temperature display for heat & cool mode.

The program schedule can be overridden by changing the set temperature (up or down button). This puts the **SC5813** thermostat into a 2-hour temporary hold. After 2 hours, it will automatically return to the program schedule.

The programmable fan feature can be used to recirculate air while in **Program** mode. It is activated during the program schedule set up.

The **SC5813** also has a button lockout feature. This enables the thermostat to be set to the proper mode and temperature and locked so it cannot be tampered with.

## Button Functions

**UP** – Used to increase the time, set temperatures and to adjust configuration settings.

**DOWN** – Used to decrease the time, set temperatures and to adjust configuration settings.

**SYS (left)** – Used to change from OFF, HEAT, EMERGENCY HEAT, COOL and AUTO changeover modes

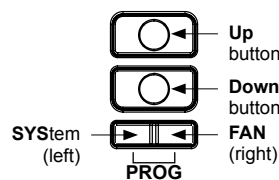

**FAN (right)** – Used to turn on and off the indoor fan.

**PROG (SYS and FAN)** – Used to change from program operation to manual operation.

**UP and PROG** – Held in simultaneously for 10 seconds to lock and unlock the thermostat.

**DOWN and SYS** – Pressed simultaneously to display outdoor remote temperature if remote sensor is connected.

## Operating Modes

There are five possible operating modes for the **SC5813**. Off, Cool, Heat, and Cool & Heat modes are accessed by pressing the **SYS** (left) button. Program mode is accessed by pressing the **SYS** (left) and **FAN** (right) buttons simultaneously.

### OFF Mode

- In this mode, the thermostat will not turn on the heating or cooling devices
- Note:** *The indoor fan can be turned on manually in every operating mode by pressing the FAN (right) button. The word FAN shows on the display and the fan icon ♫ appears when the fan operates.*

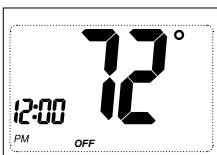

### Heat Mode

- In this mode, the thermostat controls the heating system. When the heat outputs, the flame icon 🔥 appears on the display.
- Note:** *For heat pumps, there is a four minute delay for your compressor to restart after it has turned off. To bypass the compressor time delay, go to OFF mode for 5 seconds.*



### Emergency Heat Mode (Heat pump systems only)

- In emergency heat mode, the heat pump system will be disabled and auxiliary heat will become the primary source of heat.

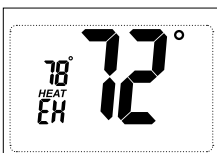

### Cool Mode

- In this mode, the thermostat controls the cooling system. When the cooling outputs, the snowflake icon ❄ appears on the display.
- Note:** *There is a four minute delay for your compressor to restart after it has turned off. To bypass the compressor time delay, go to OFF mode for 5 seconds.*

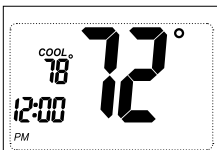

### Cool and Heat Mode (Auto Changeover)

- In this mode, the thermostat controls the cooling and heating systems, automatically changing over from one to the other as needed.
- The timing display alternates with the set temperature every 10 seconds in the cool and heat mode.

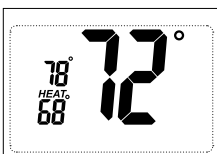

## Program Mode

- In this mode, the program function is on (**PROG** displays), and the thermostat will automatically be controlled by the set program schedule. Program mode can function with heat mode, cool mode, or heat & cool mode. The program schedule can be overridden by changing the set temperature (up or down button). After 2 hours, the program schedule will automatically be resumed. To manually return to the program schedule, press the **PROG** button twice.

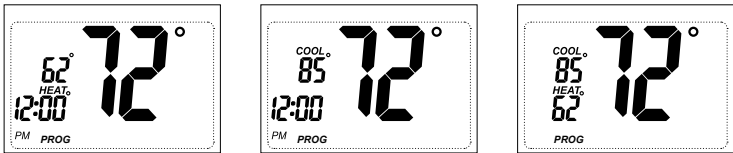

## Testing the Thermostat

Once the thermostat is configured, it should be thoroughly tested.

**CAUTION!** *Do not energize the air conditioning system when the outdoor temperature is below 50 degrees. It can result in equipment damage or personal injury.*

### Heat Test

- Press **SYS** (left) button until heat mode is displayed.
  - Adjust the set temperature so it is 5 degrees above the room temperature.
  - Heat should come on within a few seconds. Red LED may turn on.
  - Adjust the set temperature 2 degrees below the room temperature and the heat should turn off. There may be a fan delay on your system.
- Note:** *For heat pumps, there is a four-minute delay to protect your compressor after it turns off. To bypass the compressor time delay, go to OFF mode for 5 seconds.*



### Cool Test

- Press **SYS** (left) button until cool mode is displayed.
  - Adjust set temperature so it is 5 degrees below room temperature.
  - A/C should come on within a few seconds. Green LED may turn ON.
  - Adjust the set temperature 2 degrees above the room temperature and the A/C should turn off. There may be a fan delay on your system.
- Note:** *There is a four-minute time delay to protect the compressor after it turns off. To bypass the compressor time delay, go to OFF mode for 5 seconds.*



### Fan Test

- Press **FAN** (right) button. Fan displays. Indoor fan turns ON.
- Press **FAN** (right) button. Indoor fan turns OFF.

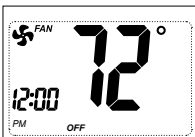

## Setting the Time and Day of the Week

The time and day of the week must be set for your program schedule to operate correctly.

- Press the **SYS** (left) button until you are in the OFF mode.
  - Press and hold the **PROG** button (**SYS** (left) and **FAN** (right) buttons pressed simultaneously) in for 6 seconds.
  - Time displays (hour flashing).  
Press the **up** or **down** button to adjust the hour.
  - Press the **FAN** (right) button once to select minutes (minutes flashing).  
Press the **up** or **down** button to adjust the minutes.
  - Press the **FAN** (right) button once to select day of the week (TODAY flashing).  
Press the **up** or **down** button to select current day of the week.
- Note:** *At any time, press the SYS (left) button to return to the previous screen or press the FAN (right) button to advance to the next screen.*



Press the **PROG** button in for 2 seconds to lock values into memory and return to the OFF mode or press the **FAN** (right) button once to enter programming.

## Programming

### Program Overview

The **SC5813** programmable thermostat has four periods (MORN, DAY, EVE, NITE) that are customizable for each day of the week. Each period will have a start time, heat temperature, cool temperature and programmable fan option. The **SC5813** monitors the day and time, while maintaining the specific conditions you have chosen for each period in your program.

Setting the program schedule:

- Press the **SYS** (left) button until you are in **OFF** mode.
- Press and hold the **PROG** button (**SYS** and **FAN** buttons pressed simultaneously) for 6 seconds.
- Press the **FAN** (right) button 3 times.
- SUN thru SAT are blinking.

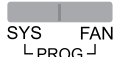

From this screen you have 2 options:

- Press the **FAN** (right) button to begin programming all 7 days at one time, or
  - Press the up button to see the other programming options.
- Note:** *The days of the week shown on the display will be programmed simultaneously. The screens are listed below.*

Screen 1	SUN	MON	TUE	WED	THU	FRI	SAT
Screen 2		MON	TUE	WED	THU	FRI	
Screen 3		MON					
Screen 4			TUE				
Screen 5				WED			
Screen 6					THU		
Screen 7						FRI	
Screen 8	SUN						SAT
Screen 9							SAT
Screen 10	SUN						

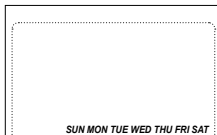

From any of the screens above, you can press the **FAN** (right) button to begin entering your program schedule. The days shown on the display will all be programmed simultaneously.

Once the **FAN** (right) button is pressed, **MORN** blinks. Use the **up** or **down** button to select a different period (**MORN**, **DAY**, **EVE**, **NITE**).

Press **FAN** (right) button to advance to the next screen. Transition time **hour** blinks. Use the **up** or **down** button to select a different hour.

Press **FAN** (right) button to advance to the next screen. Transition time **minutes** blink. Use the **up** or **down** button to select different minutes.

Press **FAN** (right) button to advance to the next screen. **Heat set temperature** displays. Use the **up** or **down** button to adjust the heat set temperature.

Press **FAN** (right) button to advance to the next screen. **Cool set temperature** displays. Use the **up** or **down** button to adjust the cool set temperature.

Press **FAN** (right) button to advance to the next screen. **Programmable fan** screen displays. Use the **up** or **down** button to select:

- Choose: **Off** – Programmable fan disabled >OR< **On** – Indoor fan on continuously
- Note:** *Programmable fan operates in Program mode only.*

Repeat above steps to program the four periods per day. When the program schedule is complete, press and hold the **PROG** button (**SYS** and **FAN** buttons pressed simultaneously) in for 2 seconds to return to the **OFF** mode.

## Lockout Feature

The **SC5813** has a button lockout feature so the mode cannot be changed and the temperature adjustment is limited. Select the appropriate lockout from Configuration Mode Settings (Step 9) of this guide.

To activate the LOCK feature:

- Simultaneously press the **SYS**, **FAN** and **UP** buttons for 10 seconds.
- Ⓐ will display and the lockout function will be enabled.

To deactivate the LOCK feature, repeat steps 1 and 2 above.

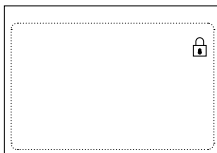

## Factory Preprogramming

The **SC5813** comes preprogrammed with the following schedule:

	MORN	6:00 AM	DAY	8:00 AM	EVE	6:00 PM	NITE	10:00 PM
MONDAY thru SUNDAY	HEAT	70°F	HEAT	62°F	HEAT	70°F	HEAT	62°F
	COOL	78°F	COOL	85°F	COOL	78°F	COOL	82°F
	FAN	Off	FAN	Off	FAN	Off	FAN	Off

## Personal Program Schedule

Use the following personal program schedule to record your settings:

	MORN	DAY	EVE	NITE
MONDAY 1	HEAT	HEAT	HEAT	HEAT
	COOL	COOL	COOL	COOL
	FAN	FAN	FAN	FAN
TUESDAY 2	HEAT	HEAT	HEAT	HEAT
	COOL	COOL	COOL	COOL
	FAN	FAN	FAN	FAN
WEDNESDAY 3	HEAT	HEAT	HEAT	HEAT
	COOL	COOL	COOL	COOL
	FAN	FAN	FAN	FAN
THURSDAY 4	HEAT	HEAT	HEAT	HEAT
	COOL	COOL	COOL	COOL
	FAN	FAN	FAN	FAN
FRIDAY 5	HEAT	HEAT	HEAT	HEAT
	COOL	COOL	COOL	COOL
	FAN	FAN	FAN	FAN
SATURDAY 6	HEAT	HEAT	HEAT	HEAT
	COOL	COOL	COOL	COOL
	FAN	FAN	FAN	FAN
SUNDAY 7	HEAT	HEAT	HEAT	HEAT
	COOL	COOL	COOL	COOL
	FAN	FAN	FAN	FAN

## SimpleSet™ Field Programming

**Requires SimpleSet™ Transfer Cable (ACC-WIH21)**

This feature is used for transferring configuration and program schedule from the master to the target thermostat. All thermostats for a job can be mounted and powered up. Configure and program one thermostat. This will be the master. The master will be used to copy the program to the rest of the thermostats.

**Preparing the master to Send:**

- The master must be powered with 24 VAC.
- Verify the master thermostat is in **OFF** mode.
- Press **SYS** (left) button until **OFF** mode displays.
- Remove cover of the master thermostat by gently pulling near one of the corners at the top of the thermostat.
  - Note:** *Do not force open. Use a small coin or slotted screwdriver to release tabs if necessary.*
- Press the **up** and **down** buttons and **CONFIG** switch simultaneously for 5 seconds.
- The **OUT** screen displays indicating the master thermostat is ready to transfer data.
  - Note:** *Press the up and down buttons and CONFIG switch simultaneously for 5 seconds to exit from data transfer mode and to return the master to the OFF mode.*
- Turn off power to the master and remove it from the wall.
- Connect the master to the target using the 3 wire connector. Attach one end to the Master's FP pins and the other end to the Target's FP pins.
  - Note:** *Target thermostat must be powered with 24 VAC for field programming to occur*

When the connection has been made correctly, the master thermostat will power up and the target will count from 5 down to 1. It will then display the **LOCK** confirming the data has been saved in memory.

When all target thermostats have been completed, reinstall the master thermostat.

Press the **up** and **down** buttons and the **CONFIG** switch simultaneously for 5 seconds to exit from the data transfer mode and to return the master thermostat to the **OFF** mode.

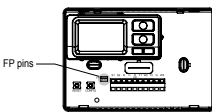
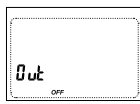

## Troubleshooting

Symptom	Remedy
No display	Check for 24 VAC at thermostat; display is blank when 24 VAC is not present Time and day of week must be reset after extended power loss
System fan does not come on properly	Verify wiring is correct, check Gas/Electric Configuration (see Setting 7)
All thermostat buttons are inoperative	Verify 24 VAC is present; unit locks out when 24 VAC is not present
No response with first button press	First button press activates backlight only
Program schedule activates at the wrong time	Check time (AM/PM) set on thermostat (see Setting the Time)
Thermostat turns on and off too frequently	Adjust temperature differential (see Configuration Mode Setting 2)
Thermostat does not follow program	Verify it is operating in program mode (PROG displays); check time (AM/PM); check if in 2 hour program override
Fan runs continuously	Press FAN (right) button to turn fan off
Status indicator light not on during call	Turn status indicator function on (see Configuration Mode Setting 16)
Room temperature is not correct	Calibrate thermostat (see Configuration Mode Setting 12) If remote sensor is used, check S1 and S2 terminal connections
Ⓐ displays when any button is pressed	Thermostat has the button lockout function activated (see Lockout Feature, and Configuration Mode Setting 9)
Er on display instead of room temperature	Check for a bad connection at S1 and S2 terminals, if used (see Configuration Mode Setting 14)
Heat or Cool not coming on	Verify wiring is correct, gently pull on each wire to verify there is a good connection at terminal block
Problem not listed above	Press Reset button once*

\* **Reset Button Function:** *Time and day are reset, configuration and program settings are unchanged.*

## FIVE-YEAR LIMITED WARRANTY

The Seller warrants its products against defects in material or workmanship for a period of five (5) years from the date of manufacture. The liability of the Seller is limited, at its option, to repair, replace or issue a non-case credit for the purchase prices of the goods which are provided to be defective. The warranty and remedies set forth herein do not apply to any goods or parts thereof which have been subjected to misuse including any use or application in violation of the Seller's instructions, neglect, tampering, improper storage, incorrect installation or servicing not performed by the Seller. In order to permit the Seller to properly administer the warranty, the Buyer shall: 1) Notify the Seller promptly of any claim, submitting date code information or any other pertinent data as requested by the Seller. 2) Permit the Seller to inspect and test the product claimed to be defective. Items claimed to be defective and are determined by Seller to be non-defective are subject to a \$30.00 per hour inspection fee. This warranty constitutes the Seller's sole liability hereunder and is in lieu of any other warranty expressed, implied or statutory. Unless otherwise stated in writing, Seller makes no warranty that the goods depicted or described herein are fit for any particular purpose.



Patent No. 424,953

7313 William Barry Blvd., North Syracuse, NY 13212  
 (Toll Free) 800-365-5525 (Phone) 315-233-5266 (Fax) 315-233-5276

www.icmcontrols.com