



# SC4011

1 Heat/1 Cool  
Auto Changeover  
Hardwire  
Non-Programmable Electronic Thermostat



- Configurable
- Single-Stage Heat/Cool Systems
- Single-Stage Heat Pump Systems
- Large Display With Backlight
- Selectable Fahrenheit or Celsius
- Compatible with Gas, Oil, or Electric
- SimpleSet™ Field Programming
- Status Indicator Light
- Relay Outputs (minimum voltage drop in thermostat)
- Remote Sensor Compatible
- Ideally Suited for:
  - Residential (New Construction/Replacement)
  - Light Commercial

## Installation, Operation & Application Guide

For more information on our complete range of American-made products – plus wiring diagrams, troubleshooting tips and more, visit us at [www.icmcontrols.com](http://www.icmcontrols.com)



## Parts Diagram

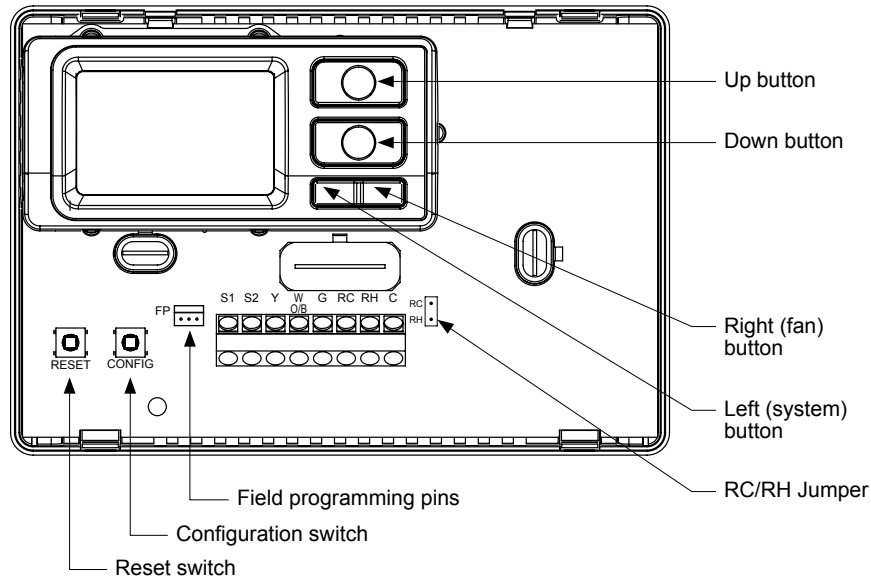

## Icon Descriptions

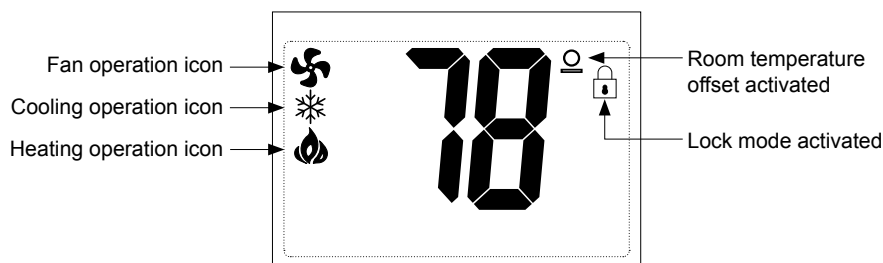

## Specifications

**Electrical rating:** • 24 VAC (18-30 VAC)

- 1 amp maximum per terminal
- 3 amp maximum total load

**Temperature control range:** 45°F to 90°F (7°C to 32°C) **Accuracy:** ± 1°F (± 0.5°C)

**System configurations:** 1-stage heat, 1-stage cool, heat pump, gas, oil, electric

**Timing:** Anti-short Cycle: 4 minutes

Backlight Operation

**Terminations:** S1, S2, Y, W/O/B, G, RC, RH, C

## Important Safety Information

**WARNING!** Always turn off power at the main power supply before installing, cleaning, or removing thermostat.

- This thermostat is for 24 VAC applications only; do not use on voltages over 30 VAC
- Do not short across terminals of gas valve or system control to test operation; this will damage your thermostat and void your warranty
- All wiring must conform to local and national electrical and building codes
- Do not use air conditioning when the outdoor temperature is below 50 degrees; this can damage your A/C system and cause personal injuries
- Use this thermostat only as described in this manual

## Package Contents/Tools Required

**Package includes:** SC4011 Pro thermostat on base, thermostat cover, wiring labels, screws and wall anchors, Installation, Operation and Application Guide

**Tools required for installation:** Drill with 3/16" bit, hammer, screwdriver

## To Remove Existing Thermostat

**ELECTRICAL SHOCK HAZARD – Turn off power at the main service panel by removing the fuse or switching the appropriate circuit breaker to the OFF position before removing the existing thermostat.**

1. Turn off power to the heating and cooling system by removing the fuse or switching the appropriate circuit breaker off.
2. Remove cover of old thermostat. This should expose the wires.
3. Label the existing wires with the enclosed wire labels before removing wires.
4. After labeling wires, remove wires from wire terminals.
5. Remove existing thermostat base from wall.
6. Refer to the following section for instructions on how to install this thermostat.

## To Install Thermostat

**ELECTRICAL SHOCK HAZARD – Turn off power at the main service panel by removing the fuse or switching the appropriate circuit breaker to the OFF position before removing the existing thermostat.**

**IMPORTANT:** Thermostat installation must conform to local and national building and electrical codes and ordinances.

⚠ **Note:** Mount the thermostat about five feet above the floor. Do not mount the thermostat on an outside wall, in direct sunlight, behind a door, or in an area affected by a vent or duct.

1. Turn off power to the heating and cooling system by removing the fuse or switching the appropriate circuit breaker off.
2. To remove cover, pull gently at the seam at the top.
3. Put thermostat base against the wall where you plan to mount it (Be sure wires will feed through the wire opening in the base of the thermostat).
4. Mark the placement of the mounting holes.
5. Set thermostat base and cover away from working area.
6. Using a 3/16" drill bit, drill holes in the places you have marked for mounting.
7. Use a hammer to tap supplied anchors in mounting holes.
8. Align thermostat base with mounting holes and feed the control wires through slit in thermal intrusion barrier and into wire opening.
9. Use supplied screws to mount thermostat base to wall.
10. For 2 transformer systems, remove and discard RC/RH jumper.
11. Insert stripped, labeled wires in matching wire terminals.

**CAUTION!** Be sure exposed portion of wires does not touch other wires.

12. Gently tug wire to be sure of proper connection. Double check that each wire is connected to the proper terminal.
13. Turn on power to the system at the main service panel.
14. Configure thermostat (see Configuration Mode Setting 4) to match the type of system you have.
15. Replace cover on thermostat by snapping it in place.
16. Test thermostat operation as described in "Testing the Thermostat".

## Wiring Diagrams

### Heating Only

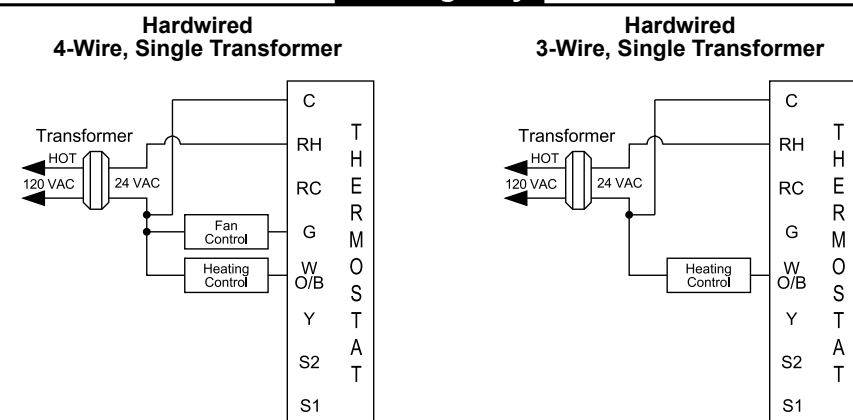

## Heating/Cooling

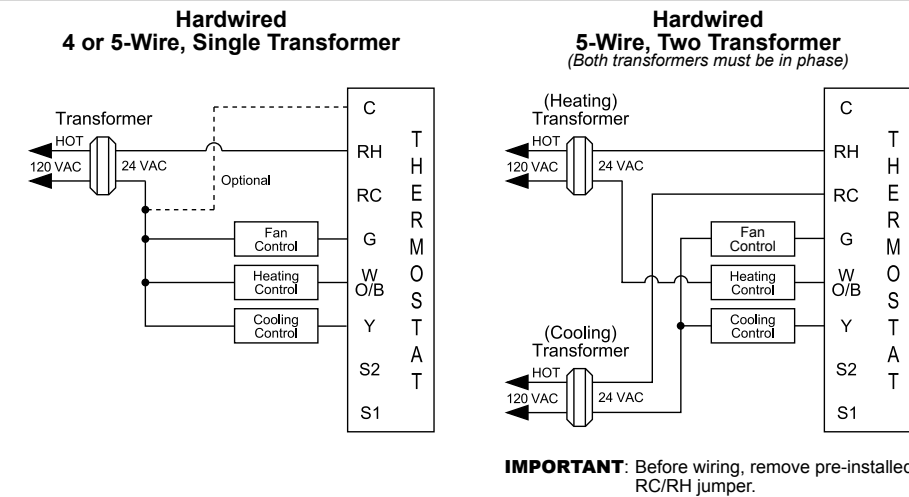

## Heat Pump

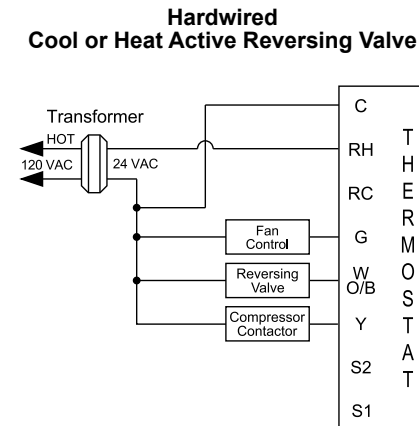

## Cooling Only

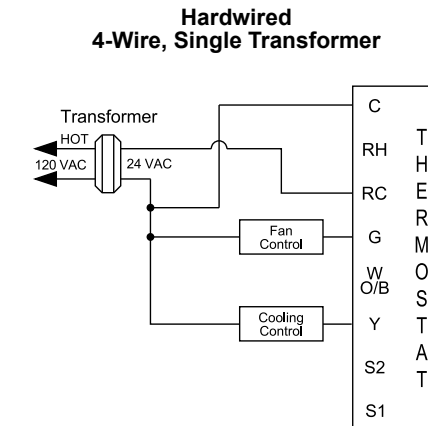

## Remote or Outdoor Sensor Installation (Optional)

1. Remove cover from remote sensor housing.
2. Select an appropriate location for mounting the remote sensor.
3. Mount remote sensor unit using hardware provided.
4. Install two strand shielded wire between remote sensor and thermostat. Shielded wire must be used. **Do not** run remote sensor wire in conduit with other wires.
  - **Wire 1** should run between the S1 terminal on the thermostat and the S1 terminal on the remote sensor
  - **Wire 2** should run between the S2 terminal on the thermostat and the S2 terminal on the remote sensor
5. Connect the shielding of the wire to the S2 terminal on the thermostat
5. Configure the thermostat to operate with the remote sensor (see Configuration Mode setting 10).

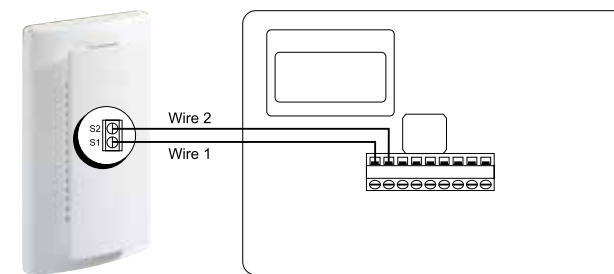

⚠ **Note:** Remote or outdoor sensor reading can be displayed by simultaneously pressing the Down and SYS buttons.

## Configuration Mode

The configuration mode is used to set the SC4011 Pro to match your heating/cooling system. The SC4011 Pro functions with heat pump, air conditioning, gas, oil or electric heat systems.

To configure the SC4011 Pro, perform the following steps:

1. Verify the SC4011 Pro is in the OFF mode.  
Press the SYS (left) button until off mode displays.

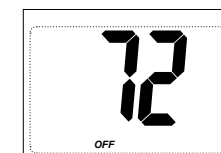

2. Remove the cover of the thermostat by gently pulling near one of the corners at the top of the thermostat.
3. Press the CONFIG button for 1 second while the SC4011 Pro is in OFF mode.

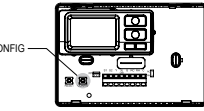

Press the up or down button to change settings within each screen.

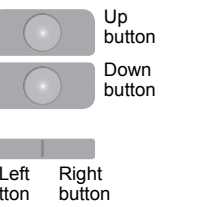

Press the right button to advance to the next screen.

⚠ **Note:** Pressing the left button will return you to the previous screen.

To exit configuration mode, press the CONFIG switch for 1 second.

## Configuration Mode Settings

The setup screens for Configuration Mode are as follows:

1. **Temperature Scale (F or C)**  
Choose Fahrenheit or Celsius.  
Press the up or down button to select.  
Press the right button to advance to the next screen.
2. **Temperature Differential (1°F to 5°F) (0.5°C to 2.5°C)**  
Set the number of degrees between your "setpoint" temperature and your "turn on" temperature.  
Press the up or down button to set differential value.  
Press the right button to advance to the next screen.
3. **Deadband (1°F - 9°F) (1°C - 5°C)**  
Set the minimum number of degrees between your heat setpoint and your cool setpoint in Autochangeover mode.  
Press the up or down button to set deadband value.  
Press the right button to advance to the next screen.

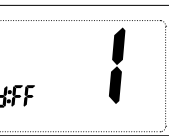

4. **System** – Set for heat pump, non-heat pump, reversing valve operation and number of compressors in your system.

| Choose        | System | Reversing Valve Active | Number of Compressors or Compressor Stages | Type of Heat |
|---------------|--------|------------------------|--|--------------|
| Heat Pump     | HP     | O                      | 1  |              |
|               | HP     | b                      | 1  |              |
| Non-Heat Pump | Heat   |                        |  | Gas          |
|               | Heat   |                        |  | Electric     |

Press the up or down button to select.  
Press the right button to advance to the next screen.

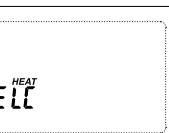

5. **Lockout (0-8°, COOL-HEAT)**  
Select the number of degrees set temperature can be changed during keypad lockout. COOL-HEAT lockout allows adjustment of the set temperatures to the maximum heat set temperature selected in Step 6 and minimum cool set temperature selected in Step 7.  
⚠ **Note:** The mode cannot be changed when the thermostat is locked.  
Press the up or down button to select.  
Press the right button to advance to the next screen.



6. **Maximum Heat Setpoint (45°F to 90°F) (7°C to 32°C)**  
Adjust to control the maximum heat set temperature allowed.  
Press the up or down button to select.  
Press the right button to advance to the next screen.



7. **Minimum Cool Setpoint (45°F to 90°F) (7°C to 32°C)**  
Adjust to control the minimum cool set temperature allowed.  
Press the up or down button to select.  
Press the right button to advance to the next screen.



8. **Room Temperature Offset (+9°F to -9°F) (+4.5°C to -4.5°C)**  
Adjust to calibrate displayed room temperature to match actual room temperature.  
⚠ **Note:** When not set to 0, e will display.  
Press the up or down button to select.  
Press the right button to advance to the next screen.

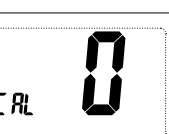

9. **Maximum Cycles Allowed Per Hour** (- -, 2-6)  
 -- = as many as needed, 2-6 = maximum cycles/hour  
 Press the **up** or **down** button to select.  
 Press the **right** button to advance to the next screen.

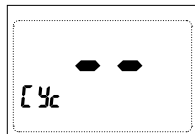

10. **Temperature Sensor** (1-3)  
 1. Only on-board sensor determines room temperature.  
 2. Only remote sensor determines room temperature.  
 3. Average temperature of on-board and remote sensor.  
 Press the **up** or **down** button to select.  
 Press the **right** button to advance to the next screen.



11. **Cooling Fan Delay Off Time** (0, 30, 60, 90 seconds)  
 Select the fan purge time for cooling.  
 Press the **up** or **down** button to select.  
 Press the **right** button to advance to the next screen.

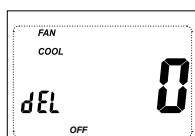

12. **Status Indicator Light** (Led 0 or 1)  
 0 = Status indicator never on  
 1 = Status indicator on with first stage  
 Press the **up** or **down** button to select.  
 Press the **CONFIG** button for 2 seconds to exit configuration.

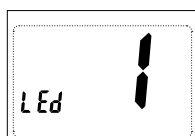

## Mode of Operation

The **SC4011 Pro** is an auto changeover, single-stage heat, single-stage cool thermostat. It functions with air conditioning, heat pumps, gas, oil or electric heat systems.

The thermostat activates the heating appliance when the room temperature is below the set heat temperature (by the differential temperature) and the red indicator light (configurable) on the thermostat will light. The **SC4011 Pro** will stop outputting and the red light will turn off when the call for heat has been satisfied. With heat pumps, the thermostat will not let the compressor come on for 4 minutes after it turns off. This protects your compressor.

When the room temperature is greater than the set cool temperature (by the differential temperature), the cooling device is activated and the green indicator light (configurable) on the thermostat will turn on. The **SC4011 Pro** will stop outputting and the green light will turn off when the call for cooling is satisfied. The thermostat will not let the compressor come on for 4 minutes after it turns off. This protects your compressor.

The **SC4011 Pro** has four possible operating modes: **OFF**, **Heat**, **Cool**, and **Heat & Cool** mode. In off mode, the thermostat will not turn on heating or cooling devices. The manual fan can be turned on in all operating modes using the fan button. In heat mode, the thermostat controls the heating system. In the cool mode, the thermostat controls the cooling system. In heat & cool mode, the thermostat controls both the heating and cooling systems. The clock display alternates with the set temperature display for heat & cool mode.

The **SC4011 Pro** also has a button lockout feature. This enables the thermostat to be set to the proper mode and temperature and locked so it cannot be tampered with.

## Operating Modes

There are four possible operating modes for the **SC4011 Pro**. Off, Cool, Heat, and Cool & Heat modes are accessed by pressing the **SYS** (left) button. Program mode is accessed by pressing the **SYS** (left) and **FAN** (right) buttons simultaneously.

### OFF Mode

- In this mode, the thermostat will not turn on the heating or cooling devices
- Note:** *The indoor fan can be turned on manually in every operating mode by pressing the **FAN** (right) button. The word **FAN** shows on the display and the fan icon  appears when the fan operates.*

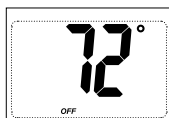

### Heat Mode

- In this mode, the thermostat controls the heating system. When the heat outputs, the flame icon  appears on the display.
- Note:** *For heat pumps, there is a four minute delay for your compressor to restart after it has turned off.*

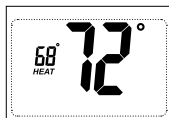

### Cool Mode

- In this mode, the thermostat controls the cooling system. When the cooling outputs, the snowflake icon  appears on the display.
- Note:** *There is a four minute delay for your compressor to restart after it has turned off.*

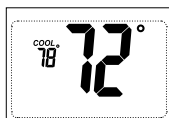

### Cool and Heat Mode (Auto Changeover)

- In this mode, the thermostat controls the cooling and heating systems, automatically changing over from one to the other as needed.
- The timing display alternates with the set temperature every 10 seconds in the cool and heat mode.

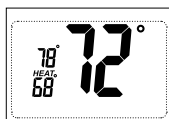

## Testing the Thermostat

Once the thermostat is configured, it should be thoroughly tested.

**CAUTION!** *Do not energize the air conditioning system when the outdoor temperature is below 50 degrees. It can result in equipment damage or personal injury.*

### Heat Test

- Press **SYS** (left) button until heat mode is displayed.
  - Adjust the set temperature so it is 5 degrees above the room temperature.
  - Heat should come on within a few seconds. Red LED may turn on.
  - Adjust the set temperature 2 degrees below the room temperature and the heat should turn off. There may be a fan delay on your system.
- Note:** *For heat pumps, there is a four-minute delay to protect your compressor after it turns off. To bypass the compressor time delay, go to **OFF** mode for 5 seconds.*

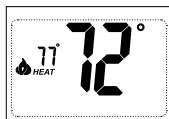

### Cool Test

- Press **SYS** (left) button until cool mode is displayed.
  - Adjust set temperature so it is 5 degrees below room temperature.
  - A/C should come on within a few seconds. Green LED may turn ON.
  - Adjust the set temperature 2 degrees above the room temperature and the A/C should turn off. There may be a fan delay on your system.
- Note:** *There is a four-minute time delay to protect the compressor after it turns off. To bypass the compressor time delay, go to **OFF** mode for 5 seconds.*

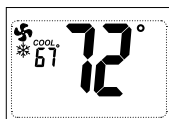

### Fan Test

- Press **FAN** (right) button. Fan displays. Indoor fan turns ON.
- Press **FAN** (right) button. Indoor fan turns OFF.

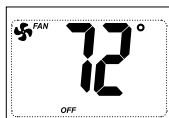

## Lockout Feature

The **SC4011 Pro** has a button lockout feature so the mode cannot be changed and the temperature adjustment is limited. Select the appropriate lockout from Configuration Mode Settings (Step 5) of this guide.

To activate the LOCK feature:

- Simultaneously press the **SYS**, **FAN** and **UP** buttons for 10 seconds.
-  will display and the lockout function will be enabled.

To deactivate the LOCK feature, repeat steps 1 and 2 above.

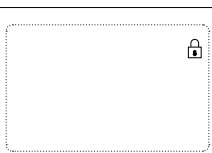

## SimpleSet™ Field Programming

Requires SimpleSet™ Transfer Cable (ACC-WIH21)

This feature is used for transferring the configuration from the master to the target thermostat. All thermostats for a job can be mounted and powered up. Configure one thermostat. This will be the master. The master will be used to copy the configuration to the rest of the thermostats.

### Preparing the master to Send:

- The master must be powered with 24 VAC.
  - Verify the master thermostat is in **OFF** mode.
  - Press **SYS** (left) button until **OFF** mode displays.
  - Remove cover of the master thermostat by gently pulling near one of the corners at the top of the thermostat.
  - Press the **up** and **down** buttons and **CONFIG** switch simultaneously for 5 seconds.
  - The **OUT** screen displays indicating the master thermostat is ready to transfer data.
- Note:** *Press the **up** and **down** buttons and **CONFIG** switch simultaneously for 5 seconds to exit from data transfer mode and to return the master to the **OFF** mode.*
- Turn off power to the master and remove it from the wall.
  - Connect the master to the target using the 3 wire connector. Attach one end to the Master's FP pins and the other end to the Target's FP pins.
- Note:** *Target thermostat must be powered with 24 VAC for field programming to occur.*

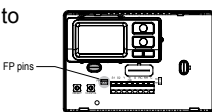
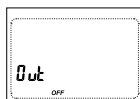
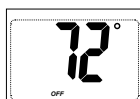

When the connection has been made correctly, the master thermostat will power up and the target will count from 5 down to 1. It will then display the **LOCK** confirming the data has been saved in memory.

When all target thermostats have been completed, reinstall the master thermostat.

Press the **up** and **down** buttons and the **CONFIG** switch simultaneously for 5 seconds to exit from the data transfer mode and to return the master thermostat to the **OFF** mode.

## Troubleshooting

| Symptom   | Remedy   |
|---|--|
| No display  | Check for 24 VAC at thermostat; display is blank when 24 VAC is not present  |
| System fan does not come on properly  | Verify wiring is correct, check Gas/Electric Configuration (see Setting 4)   |
| All thermostat buttons are inoperative  | Verify 24 VAC is present; unit locks out when 24 VAC is not present  |
| No response with first button press   | First button press activates backlight only  |
| Thermostat turns on and off too frequently  | Adjust temperature differential (see Configuration Mode Setting 2)   |
| Fan runs continuously   | Press FAN (right) button to turn fan off   |
| Status indicator light not on during call   | Turn status indicator function on (see Configuration Mode Setting 12)  |
| Room temperature is not correct   | Calibrate thermostat (see Configuration Mode Setting 8)<br>If remote sensor is used, check S1 and S2 terminal connections      |
|  displays when any button is pressed | Thermostat has the button lockout function activated (see Lockout Feature, and Configuration Mode Setting 5)                   |
| $E_r$ or $S_{En}$ on display instead of room temp.  | Check for a bad connection at S1 and S2 terminals, if used (see Configuration Mode Setting 10)                                 |
| Heat or Cool not coming on  | Verify wiring is correct, verify RC/RH jumper is in place (for single transformer system)                                      |
| Remote or outdoor sensor not accurate   | Press SYS and Down buttons simultaneously to display remote or outdoor temperature. Verify connections at S1 and S2 terminals. |
| Problem not listed above  | Press Reset button once*   |

\* **Reset Button Function:** Time and day are reset, configuration settings are unchanged.

## FIVE-YEAR LIMITED WARRANTY

The Seller warrants its products against defects in material or workmanship for a period of five (5) years from the date of manufacture. The liability of the Seller is limited, at its option, to repair, replace or issue a non-case credit for the purchase prices of the goods which are provided to be defective. The warranty and remedies set forth herein do not apply to any goods or parts thereof which have been subjected to misuse including any use or application in violation of the Seller's instructions, neglect, tampering, improper storage, incorrect installation or servicing not performed by the Seller. In order to permit the Seller to properly administer the warranty, the Buyer shall: 1) Notify the Seller promptly of any claim, submitting date code information or any other pertinent data as requested by the Seller. 2) Permit the Seller to inspect and test the product claimed to be defective. Items claimed to be defective and are determined by Seller to be non-defective are subject to a \$30.00 per hour inspection fee. This warranty constitutes the Seller's sole liability hereunder and is in lieu of any other warranty expressed, implied or statutory. Unless otherwise stated in writing, Seller makes no warranty that the goods depicted or described herein are fit for any particular purpose.



Patent No. - Design: 424,953  
 Patent No. - Thermal Intrusion Barrier: 6,597,275  
 Patent Pending - SimpleSet™ Target Programming Technology

7313 William Barry Blvd., North Syracuse, NY 13212  
 (Toll Free) 800-365-5525 (Phone) 315-233-5266 (Fax) 315-233-5276